

Causality and Econometrics:

Part II

James Heckman and Rodrigo Pinto

Econ 312, Spring 2023

1. The Neyman-Rubin (NR) Causal Model

- The Neyman-Rubin causal approach uses the language and framework of experimental design developed by Fisher, Rubin, and Holland and popularized by Angrist.
- It ignores essential aspects of the econometric approach to causality and conflates distinct concepts (e.g., SUTVA).¹

¹(Angrist) explains that SUTVA - Stable Unit Treatment Value Assumption - is a mixture of two two distinct concepts regarding function autonomy and no interaction among agents.

- It does not define hypothetical models nor does it employ structural equations to characterize causal models.
- It focuses on units of analysis instead of system of equations.
- Causal models are characterized by statistical independence relationships among counterfactual counterparts of observed variables, never precisely defined.
- The NR approach lacks the clarity of interpretation offered by causal models described by structural equations.
- It is very often difficult to map the independence relationships of a NR model into the actual causal relationships produced by economic theory.
- In particular, NR makes it difficult to assess the credibility of assumptions that ensure the identification of causal effects.

- Another drawback is that the NR framework lacks fundamental tools of econometric causal analysis.
- It does not explicitly model unobserved variables in structural models.
- This feature substantially limits the use of the tools explicated in Section ??.
- It rules out (or makes cumbersome) several fruitful econometric strategies such as balancing bias within models using compensating variations of arguments of structural functions to keep agents at the same levels of well being,² and cross-equation restrictions on both observable and unobservable model components, or functional form restrictions.

²See e.g., ??.

- In practice, the set of tractable identification strategies that employ the NR framework is limited to a few possibilities: randomized trials, IV and its many surrogates and differences-in-differences (see ?). This section illustrates drawbacks of NR in analyzing core policy questions.

The Generalized Roy Model under NR

- The NR framework focuses on the unit of analysis $i \in \mathcal{I}$ which usually represents an economic agent or entity.
- The framework describes part of the Generalized Roy model (??)–(??) using two counterfactuals: $T_i(z)$ is the potential treatment when the instrument Z is set to value $z \in \text{supp}(Z)$; and $Y_i(t, z)$ is the potential outcome of agent i when Z is set to value $z \in \text{supp}(Z)$ and choice T is set to $t \in \text{supp}(T)$.
- It does not explicitly characterize the choice equation.
- It prides itself on being nonparametric, although some proponents claim that assuming linearity is an assumption, even when models are fundamentally nonlinear.³

³?. ? show that nonlinearity is intrinsic to hedonic models and that linearizing it produces identification problems.

- The NR framework characterises the Generalized Roy model (??)–(??) by three assumptions:
 - ① An exclusion restriction states that $Y_i(t, z) = Y_i(t, z')$ for all $z, z' \in \text{supp}(Z)$ and for all $i \in \mathcal{I}$.
 - ② IV relevance: Z is not statistically independent of T , that is $Z \not\perp T$.
 - ③ Exogeneity condition $Z \perp\!\!\!\perp (Y(t), T(z))$.

- The exclusion restriction means that Z does not directly cause Y . Thus, we can express the counterfactual outcome as $Y_i(t)$ instead of $Y_i(t, z)$.
- IV relevance means that T is caused by Z .
- The exogeneity condition of the NR framework can be traced back to the independence relationship between Z and V of the Generalized Roy model (??)–(??).
- In the NR framework, the exogeneity condition is an assumption.
- In the Generalized Roy model, the exogeneity condition is a consequence of the causal relation among model variables.
- Namely, that the Z and V are external variables.
- The LMC (??) implies that $Z \perp\!\!\!\perp V$, which, in turn, generates the exogeneity condition.

- The identification of counterfactual outcomes requires additional assumptions.
- A popular assumption securing identification is the monotonicity condition (1) of ?.
- It states that a change in an instrument induces agents to change their treatment choice towards the same direction.
- Notationally, for any $z, z' \in \text{supp}(Z)$, we have that:

$$T_i(z) \geq T_i(z') \quad \forall i \in \mathcal{I} \quad \text{or} \quad T_i(z) \leq T_i(z') \quad \forall i \in \mathcal{I} \quad (1)$$

- ? shows that the monotonicity condition (1) is equivalent to the separability assumption $T = \mathbf{1}[\zeta(Z) \geq \phi(V)]$.
- Otherwise stated, the NR counterpart for the Generalized Roy model separability assumption is the monotonicity condition.
- Each condition enables the identification of causal effects of T on Y in its respective framework.
- At this level, the IV models in the two frameworks are equivalent.

- Model equivalence does not, however, imply that they offer the same analytical capacities.
- In particular, the Generalized Roy model (??)–(??) explicitly displays the unobserved confounding variable V , while NR does not.
- This feature enables analysts to further investigate the model and use other approaches for controlling for it.
- Section ?? shows that the identification of counterfactual outcomes hinges on the analysts's ability to control for the unobserved confounding variable V .

- ? use the fact that U is a balancing score for V to define and identify a new parameter called the marginal treatment effect (MTE):

$$MTE(u) = E_h(Y | \tilde{T} = 1, U = u) - E_h(Y | \tilde{T} = 0, U = u) = E_{e^*}(Y(1) - Y(0) | U = u).$$

- The MTE plays a primary role in generating a range of causal effects commonly sought in policy evaluations.
- A few of these causal parameters are presented in Table 1.

Table 1: Some Causal Parameters as Weighted Average the MTE

Causal Parameters	MTE Representation	Weights
$ATE = E(Y(1) - Y(0))$	$= \int_0^1 MTE(p) W^{ATE}(p) dp$	$W^{ATE}(p) = 1$
$TT = E(Y(1) - Y(0) \mid T = 1)$	$= \int_0^1 MTE(p) W^{TT}(p) dp$	$W^{TT}(p) = \frac{1 - F_P(p)}{\int_0^1 (1 - F_P(t)) dt}$
$TUT = E(Y(1) - Y(0) \mid T = t_0)$	$= \int_0^1 \Delta^{MTE}(p) W^{TUT}(p) dp$	$W^{TUT}(p) = \frac{F_P(p)}{\int_0^1 (1 - F_P(t)) dt}$
$TSLS = \frac{Cov(Y, Z)}{Cov(T, Z)}$	$= \int_0^1 MTE(p) W^{TSLS}(p) dp$	$W^{TSLS}(p) = \frac{\int_0^1 (t - E(P)) dF_P(t)}{\int_0^1 (t - E(P))^2 dF_P(t)}$
$LATE = \frac{E(Y \mid Z = z_1) - E(Y \mid Z = z_0)}{P(z_1) - P(z_0)}$	$= \int_{P(z_0)}^{P(z_1)} MTE(p) W^{LATE}(p) dp$	$W^{LATE}(p) = \frac{1}{P(z_1) - P(z_0)}$

Source: ?.

- The power of analysis generated by switching from the NR framework to a structural equation framework is substantial.
- The use of structural equations facilitates a richer analysis and a deeper investigation of the properties of the Generalized Roy model.
- Such analyses cannot be achieved in the NR framework because it does not include unobserved variables, nor does it employ structural equations.
- This analytical deficiency of the NR framework limits the researcher's ability to extend causal analysis of the Generalized Roy model and other economic models.

- The parsimonious machinery of the NR framework is often misunderstood as endowing the Generalized Roy model with a greater level of generality.
- This impression is misleading as the IV model featured in the NR framework is equivalent to the Generalized Roy model described by equations (??)–(??) and its monotonicity criteria is equivalent to a separability condition. Its apparent simplicity is due to its lack of explicit statement of its assumptions.

The Matching Model in the NR

- A common identification approach in NR is a *matching* assumption on observed variables.
- It states that the treatment choice T is independent of counterfactual outcomes $Y(t)$ when conditioning on observed pre-treatment variables X , that is, $Y(t) \perp\!\!\!\perp T \mid X$.⁴
- Intuitively, the assumption states that pre-treatment variables X are sufficiently rich to account for all the unobserved variables that jointly influence treatment choice T and outcome Y . The assumption can be easily criticized as often being overly optimistic for the case of observational studies (??).

⁴In the language of ?, X *d-separates* Y and T .

- It is natural to infer that increasing the number of matching variables may only decrease the potential bias generated by unobserved confounders.
- This statement is known to be false.⁵
- However it is rather difficult to investigate the truth of this claim using the NR framework. The causal model of Table 2 clarifies this point.

⁵See, for instance, ???.

Table 2: Hypothetical Matching Model

Causal Model	DAG	Independence Relationships
$V = f_V(\epsilon_V)$ $J = f_J(\epsilon_J)$ $W = f_W(\epsilon_W)$ $V = f_V(\epsilon_V)$ $T = f_T(V, W, \epsilon_T)$ $K = f_K(T, V, \epsilon_K)$ $U = f_U(K, \epsilon_U)$ $X = f_X(W, J, \epsilon_X)$ $Y = f_Y(T, K, U, J, \epsilon_Y)$	<pre> graph TD V((V)) --> T[T] W((W)) --> T J((J)) --> T T --> K[K] V --> K K --> Y[Y] U((U)) --> Y W --> X[X] J --> X </pre>	$Y(t) \perp\!\!\!\perp T \mid K$ $Y(t) \not\perp\!\!\!\perp T \mid X$ $Y(t) \not\perp\!\!\!\perp T \mid (X, K)$

- The causal model Table 2 comprises four observed variables: the treatment T , the outcome Y , a pre-treatment variable X and a post-treatment variable K .
- The model also contains four unobserved variables V, U, W, J . The causal relationship among observed and unobserved variables renders $Y(t) \perp\!\!\!\perp T \mid K$ even though $Y(t) \not\perp\!\!\!\perp T \mid X$.
- The independence relationship that characterises the matching assumption holds for post-treatment variables, but not for the pre-treatment variable. Moreover, adding the pre-program variable X to the conditioning set of $Y(t) \perp\!\!\!\perp T \mid K$ prevents identification because $Y(t) \not\perp\!\!\!\perp T \mid (X, K)$.

- The causal model of Table 2 exemplifies the difficulty of performing causal investigation within the NR framework. The unusual properties of the model stem from the particular causal relationships among its observed and unobserved variables. This model is not easily analyzed within the NR framework because it lacks unobserved variables and suppresses the structural equations that clearly describe the causal relationships among variables.

Mediation Models under NR: An example

- Mediation models originate in the path analysis and simultaneous equations literatures.⁶ They trace the impacts of interventions on outcomes through their multiple channels of operation.
- Identifying the causal models generated by NR assumptions is often a daunting task and the economic content of these assumptions is often far from clear.

⁶See ????.

- We examine several mediation models to illustrate this fact and show the power of the econometric approach compared to an approach based on NR principles.
- Table 3 uses the econometric approach to present a general mediation model in which a treatment T causes a mediator M and an outcome Y that is caused by both T and M . \mathbf{V} denotes a random vector that plays the role of the unobserved confounder causing T , M and Y . The counterfactual mediator when the treatment is fixed at $t \in \text{supp}(T)$ is $M(t) = f_M(t, \mathbf{V}, \epsilon_M)$.
- The counterfactual outcome when the treatment is fixed at t and the mediator is fixed at $m \in \{0, 1\}$ is

$Y(t, m) = f_Y(t, m, \mathbf{V}, \epsilon_Y)$. The counterfactual outcome when we fix only T at t is $Y(t) = f_Y(t, M(t), \mathbf{V}, \epsilon_Y)$.

Table 3: Mediation Model with Confounding Variable

Causal Model	DAG
$\mathbf{V} = f_V(\epsilon_V)$ $T = f_T(\mathbf{V}, \epsilon_T)$ $M = f_M(T, \mathbf{V}, \epsilon_M)$ $Y = f_Y(T, M, \mathbf{V}, \epsilon_Y)$	<pre> graph TD V((V)) --> T[T] V --> M[M] V --> Y[Y] T --> M M --> Y T --> Y </pre>

- The goal of mediation models is to decompose the total effect of T on Y into an indirect effect that includes the effect of T on M and M on Y and a direct effect not mediated by M .
- To facilitate the discussion, let T and M denote binary variables taking values in $\{0, 1\}$.
- The average (total) effect of T on Y is $E_{e^*}(Y(1) - Y(0))$.
- We can also define the average direct effect of T on Y as

$$E_{e^*}(Y(1, M) - Y(0, M)) = \sum_{m=0}^1 E_{e^*}(Y(1, m) - Y(0, m))P_e(M = m)$$

and the average indirect effect as

$$E_{e^*}(Y(T, 0) - Y(T, 1)) = \sum_{t=0}^1 E_{e^*}(Y(t, 1) - Y(t, 0))P_e(T = t).^7$$

⁷Alternatively, we can then define the direct effect and indirect effects for a given t by (2) and (3) respectively.

$$DE(t) = E_{e^*}(Y(1, M(t)) - Y(0, M(t))) = \int E_{e^*}(Y(1, m) - Y(0, m))dF_{M(t)}(m) \quad (2)$$

- Table 4 displays three hypothetical models suitable for examining the total, direct and indirect effects. The first DAG corresponds to the total effect. The hypothetical variable \tilde{T} replaces the T -input of both the mediator M and the outcome Y equations. The second DAG corresponds to the indirect effect only and the hypothetical variable replaces only the T -input of the mediator equation.
- The last DAG corresponds to the direct effect only where the hypothetical variable \tilde{T} replaces only the T -input of outcome equation.

Table 4: Hypothetical Models for the Mediation Model: Total, Direct and Indirect Effects

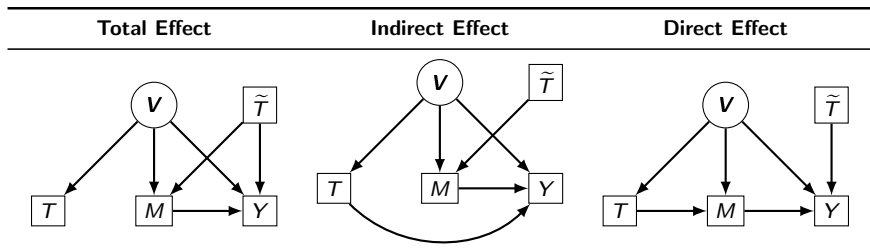

- The confounding variable \mathbf{V} prevents the identification of the counterfactual means $E_{e^*}(M(t))$ and $E_{e^*}(Y(t, m))$.
- A solution to this identification problem using NR is the Sequential Ignorability (SI):⁸

$$(Y(t', m), M(t)) \perp\!\!\!\perp T, \quad (4)$$

$$Y(t', m) \perp\!\!\!\perp M(t) \mid T, \quad (5)$$

for any $t, t' \in \text{supp}(T)$ and $m \in \text{supp}(M)$.

- SI (4)–(5) enables analysts to identify counterfactual means by statistical conditioning $E_e(M(t)) = E_{e^*}(M \mid T = t)$ and $E_{e^*}(Y(t, m)) = E_e(Y \mid T = t, M = m)$.

⁸See ?? for the properties of these assumptions.

- SI assumptions (4)–(5) can be understood as an application of the matching condition to mediation models.
- Assumption (4) states that the choice T is exogenous with respect to the outcome and mediator counterfactuals.
- The assumption would be justified if T were randomly assigned by a RCT experiment.
- The interpretation of assumption (5) is less straightforward.
- It states that the counterfactual mediator $M(t)$ is independent of the counterfactual outcome $Y(t, m)$ when conditioned on T .
- The assumption cannot be directly tested even in randomized experiments (?).
- SI assumptions (4)–(5) are much more easily interpreted using structural equations.
- The assumptions rule out any confounding variable V , generating the model in Table 5.

Table 5: Mediation Model with No Confounding Variables

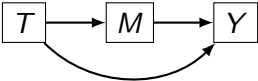
Causal Model	DAG
$T = f_T(\epsilon_T)$ $M = f_M(T, \epsilon_M)$ $Y = f_Y(T, M, \epsilon_Y)$	 <pre> graph LR T[T] --> M[M] M[M] --> Y[Y] T[T] --> Y[Y] </pre>

- SI assumptions (4)–(5) are rather strong.
- They can be weakened if instrumental variables are available as depicted in Table 6.
- We use the model to exemplify a case in which NR assumptions are logically possible but generate a causal model that is difficult to justify using any plausible argument. The structural model enables the analyst to interpret the statistical assumptions using behavioral theory.

Table 6: Mediation Model with Instrumental Variables

Causal Model	DAG
$\mathbf{V} = f_V(\epsilon_V)$ $Z = f_Z(\epsilon_Z)$ $T = f_T(Z, \mathbf{V}, \epsilon_T)$ $M = f_M(T, \mathbf{V}, \epsilon_M)$ $Y = f_Y(T, M, \mathbf{V}, \epsilon_Y)$	<pre> graph TD Z[Z] --> T[T] V((V)) --> T V --> M[M] V --> Y[Y] T --> M M --> Y T --> Y </pre>

- The mediation model with IV has four counterfactuals, $T(z)$, $M(t)$, $Y(t)$, $Y(t, m)$ previously defined.
- In language of NR, the model would be characterized by IV exogeneity condition $Z \perp\!\!\!\perp (T(z), M(t), Y(t), Y(t, m))$.
- The condition holds due to the independence of Z and \mathbf{V} ⁹.
- Suppressing Y generates an IV model where M plays the role of the outcome.
- To dig more deeply, investigate the case of a binary instrument $Z \in \{0, 1\}$.

⁹Note that if we were to suppress M from the DAG of Table 6, we would obtain the empirical model of Table ??

- The response vector $\mathbf{S}_i = [T_i(0), T_i(1)]'$ denotes the vector of treatment choices that agent i would take if it were assigned to each of the instrumental values. Section ?? shows that, given \mathbf{S} , the treatment choice T depends only on the instrument Z .
- The exogeneity condition states Z is independent of the counterfactual outcome $Y(t)$. Thus

$$T \perp\!\!\!\perp Y(t) \mid \mathbf{S}. \quad (6)$$

\mathbf{S} is a balancing score for \mathbf{V} .

- ? uses the language of NR to identify mediation effects using instrumental variables.
- His solution merges SI (4)-(5) with the matching property of the response vector \mathbf{S} in (6).
- He advocates an assumption that he terms the *local average causal mediation effects (LACME) assumption*:

$$(Y(t, m), M(t')) \perp\!\!\!\perp T \mid (\mathbf{S} = [0, 1]'), \quad (7)$$

$$Y(t, m) \perp\!\!\!\perp M(t') \mid (T, \mathbf{S} = [0, 1]'). \quad (8)$$

- LACME (7)–(8) adds the the response vector \mathbf{S} as an additional conditioning variable to the SI independence relationships in (4)–(5).
- Assumption (7) is a simple extension of the matching property of \mathbf{S} from the IV model of Table 5 to the mediator model of Table 6. Under monotonicity (1), the LACME assumption identifies the direct and indirect mediation effects for compliers.

- It is easy to interpret LACME in terms of NR assumptions: assumptions(7)–(8) are a weaker version of SI (4)-(5) that incorporates the LATE analysis of ?.
- On the other hand, it is difficult to gauge how the LACME assumptions fit into the mediation model of Table 3.
- It is even harder to interpret the causal content of these assumptions.

- Table 7 presents two DAGs that use the structural approach to clarify the causal content of LACME.
- The first DAG places the unobserved response vector \mathbf{S} into the mediation model of Table 3.
- The response vector \mathbf{S} plays the role of a balancing score for \mathbf{V} only for choice T .¹⁰
- The addition of the response vector does not result in any loss of generality.

¹⁰This property is based on the discreteness of the instrument.

- The second DAG displays the mediation model under LACME.
- According to assumption (8), the response vector \mathbf{S} plays the role of a balancing score for T and M .
- In addition, LACME prevents \mathbf{V} from jointly causing M , Y and implies that \mathbf{S} directly causes M , Y . It is hard to translate LACME into credible causal relationships.

- $\mathbf{S} = [T(0), T(1)]'$ is expressed as a function of the confounding variable \mathbf{V} because $T(z)$ is a function of \mathbf{V} . Note that the choice T is expressed as a function of \mathbf{S} and Z because $T = [\mathbf{1}[Z = 0], \mathbf{1}[Z = 1]] \mathbf{S}$.
- The response vector $\mathbf{S} = [T(0), T(1)]'$ is expressed as a function of the confounding variable \mathbf{V} because $T(z)$ is a function of \mathbf{V} .
- The resulting DAG does not include more information than the original model of Table 3 because \mathbf{S} is unobserved.

- The second DAG displays the mediation model under LACME. From assumption (8), the response vector \mathbf{S} plays the role of a matching variable for the causal effect of M on Y . It plays the role of a balancing score for \mathbf{V} for T , M , and Y . The assumption prevents \mathbf{V} from jointly causing M , Y and implies that \mathbf{S} directly causes M , Y .
- It is hard to produce interpretable models that justify \mathbf{S} as a cause of M or Y . LACME is an unmotivated but statistically useful assumption.

Table 7: Mediation Model including **S** and the Mediation Model under LACME Assumption

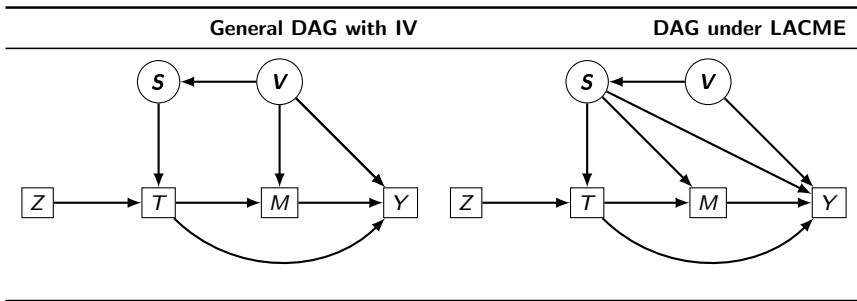

Using Structural Equations to Identify the Mediation Model with IV

- ? study the identification of causal effects for the mediation model with an instrumental variable.
- Their analysis illustrates the gain in clarity and scrutiny when a causal model is expressed by structural equations instead of NR statistical independence relationships.
- A typical empirical setting of an IV model consist of one instrument and various outcomes.
- A mediation model with an instrument arises when treatment causes an intermediate outcome (the mediator), which in turn causes a final outcome. The DAG of this empirical model is presented in the first column of Table 8.

- The second column of Table 8 presents the DAG generated by suppressing the final outcome. The resulting DAG is an IV model like that examined in Section ???. The causal effect of T on M can be identified by the methods discussed in Section ??.
- The third column of Table 8 suppresses the mediator M .
- The resulting model is also an IV model. This means that the *total effect* of T on Y can also be identified by the methods of Section ??.
- Unfortunately, the IV does *not* identify the causal effect of M on Y . Consequently, mediation analysis cannot be conducted without further assumptions.

Table 8: Dissecting the Mediation Model

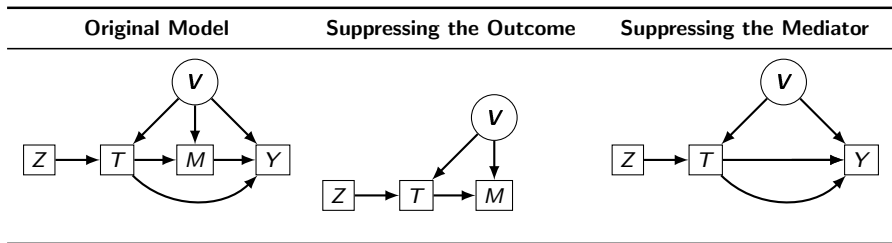

- ? address the question of whether it is possible to use an instrumental variable Z to nonparametrically identify the causal chain connecting T , M , Y while maintaining the endogeneity of the treatment T with respect to the mediator M and outcome Y .
- They show that the only solution to this problem is to assume the partially confounded mediation model of Table 9.

Table 9: Partially Confounded Model with Instrumental Variables

Causal Model	DAG
$\mathbf{V}_T = f_{V_T}(\epsilon_{V_T})$ $\mathbf{V}_Y = f_{V_Y}(\epsilon_{V_Y})$ $Z = f_Z(\epsilon_Z)$ $T = f_T(Z, \mathbf{V}_T, \epsilon_T)$ $M = f_M(T, \mathbf{V}_T, \mathbf{V}_Y, \epsilon_M)$ $Y = f_Y(T, M, \mathbf{V}_Y, \epsilon_Y)$	<p>The DAG illustrates the causal structure. Nodes Z, T, M, and Y are represented by squares, while V_T and V_Y are represented by circles. Directed edges (arrows) indicate causal relationships: Z points to T; V_T points to both T and M; V_Y points to both M and Y; T points to M; and M points to Y. A curved arrow also points from T to Y, representing a direct causal effect.</p>

- The partially confounded assumption is that $\mathbf{V}_T \perp\!\!\!\perp \mathbf{V}_Y$.
- The assumption generates an additional exogeneity condition $(M(z), Y(m, t)) \perp\!\!\!\perp Z \mid (T = t)$ while maintaining the endogeneity of the treatment T with respect to M and Y . This means that Z is a valid instrument for identifying the causal effect of M on Y when conditioning on the treatment variable T . If the assumption holds, the causal effect of M on T can be evaluated by the methods of Section ??.
- ? discuss the intuition, plausibility, and estimation of the partially confounded mediation model. They illustrate a range of examples where the partially confounding assumption may hold and where it does not.

2. The Do-Calculus and the Hypothetical Model

- This section compares the *do*-calculus (DoC) of Pearl (2000) with the Neyman-Rubin (NR) framework of Rubin (1974) and the Hypothetical Model (HM) approach of Pearl (2000).
- The DoC was first presented in Pearl (2000).
- The method employs graph theory-based algorithms to identify the probability distribution of counterfactual variables in causal models represented by DAGs.¹¹
- In contrast with NR, DoC is based on autonomous structural equations.
- The method clearly describes the causal relationships between model variables and does not encounter the problematic causal interpretations of the NR approach.

¹¹For a recent book on the graphical approach to causality, see Pearl (2009), and for related works on causal discovery, see Spirtes, Glymour, and Scheines (2000), and Pearl (2000).

- The DoC applies to any nonparametric and recursive system of structural equations.
- Similar to the HM, DoC allows for unobserved variables.
- It can be applied to multiple equation causal models and a range of causal inquiries.
- The HM and the DoC differ greatly regarding counterfactual manipulations.
- To address the causal operation of fixing, the HM solution uses a hypothetical model that formalizes the notion of thought experiments and places it on a sound probabilistic footing. Contrary to HM, DoC defines hypothetical models by making manipulations *within* the empirical model. The method implements the notion of setting or fixing using a set of rules that combine graphical analysis, independence relationships and probability equalities.

- Some notation is required to explain the method. Let G denote a DAG that represents the original causal model. Let Y, K, X, T denote disjoint variable sets in \mathcal{T} .
- In DoC notation, $T(X)$ denotes the variables in T that do not directly or indirectly cause X . The DoC uses $G_{\bar{K}}$ for the derived DAG that deletes all causal arrows arriving at K in the original DAG G .
- $G_{\underline{T}}$ denotes the DAG that deletes all causal arrows emerging from T . In this notation, $G_{\bar{K}, \underline{T}}$ stands for the derived DAG that suppresses all arrows arriving at K and emerging from T , while $G_{\overline{K, T(X)}}$ deletes all arrows arriving at K in addition to arrows arriving at $T(X)$, namely, arriving at variables in T that are not ancestors of X .

- The DoC uses three rules.
- Each rule combines a graphical condition and a conditional independence relation that, when satisfied, imply a probability equality: **The Three DoC Rules**
 - ① Rule 1: if $Y \perp\!\!\!\perp T \mid (K, X)$ holds in $G_{\overline{K}}$, then $P(Y \mid do(K), T, X) = P(Y \mid do(K), X)$,
 - ② Rule 2: if $Y \perp\!\!\!\perp T \mid (K, X)$ holds in $G_{\overline{K}, \overline{T}}$, then $P(Y \mid do(K), do(T), X) = P(Y \mid do(K), \overline{T}, X)$,
 - ③ Rule 3: if $Y \perp\!\!\!\perp T \mid (K, X)$ holds in $G_{\overline{K}, \overline{T(X)}}$, then $P(Y \mid do(K), do(T), X) = P(Y \mid do(K), X)$,
- The process of checking if a causal effect is identified requires reiterative use of these rules. We present several examples of how to use the DoC method below.

- In computer science, the DoC is said to be “complete.” This is different from the notion of completeness as defined in simultaneous equations theory discussed in Section ??.
- The DoC notion is that if a causal effect is identifiable, it can be identified by the iterative application of some sequence of the three rules (??).

- A major limitation of do-calculus is that it only applies to non-parametric models that can be fully characterized by a DAG.
- Otherwise stated, the method does not account for assumptions about the functional forms of the structural equations or cross covariance restrictions.
- This limitation hinders the application of most of the popular econometric tools used in empirical economics such as cross equation restrictions, separability, additivity or monotonicity assumptions.
- For instance, the Generalized Roy model is not identified by DoC because it requires assumptions such as separability. The same is true of the IV model. Separability cannot be characterized by conditional independence assumptions generated by a DAG.
- By the rules of do-calculus, the IV model and the Roy model are not identified. We now demonstrate these points.

Using Do-Calculus to Investigate the Roy Model

- We show the limitations of the DoC for identifying the Roy model.

Table 10: Using Do-Calculus to Investigate the Roy Model

Original DAG G	Derived DAG G_Z	Derived DAG G_T	Derived DAG $G_{\bar{T}, Z}$

- The first column of Table 10 presents the DAG of the original Roy model, which is denoted by G .
- The second column displays the DAG $G_{\underline{Z}}$ which suppresses the arrow arising from Z .
- The LMC of Z on DAG $G_{\underline{Z}}$ is $Z \perp\!\!\!\perp (Y, T)$.
- From Rule 2 of DoC, we obtain $P(T \mid do(Z)) = P(T \mid Z)$.
- Summarizing:

$$G_{\underline{Z}} \Rightarrow T \perp\!\!\!\perp Z, \Rightarrow \text{by Rule 2 } P(T \mid do(Z)) = P(T \mid Z). \quad (9)$$

- This says that Z is statistically independent of T when we fix Z .
- In the NR framework, this is the exogeneity condition $T(z) \perp\!\!\!\perp Z$, namely, that the instrument Z is independent of the counterfactual choice $T(z)$. Instrument Z in DAG $G_{\underline{Z}}$ is independent of both T and Y . Thus we can replace T by Y in (9) to obtain $P(Y \mid do(Z)) = P(Y \mid Z)$.
- This means that conditioning on Z is equivalent to fixing Z . Indeed the instrument Z is an external variable and the causal operation of fixing is translated to standard statistical conditioning.

- The third column of Table 10 displays the DAG $G_{\overline{T}}$ which suppresses the arrow arriving at T .
- LMC of Z on $G_{\overline{T}}$ implies $Z \perp\!\!\!\perp Y$.
- By Rule 1 of DoC, we have that $P(Y \mid do(T), Z) = P(Y \mid do(T))$.
- Summarizing:

$$G_{\overline{Z}} \Rightarrow Y \perp\!\!\!\perp Z, \Rightarrow \text{by Rule 1 } P(Y \mid do(T), Z) = P(Y \mid do(T)). \quad (10)$$

- This means that Z is statistically independent of Y when we fix T .
- This statement refers to the exogeneity condition $Y(t) \perp\!\!\!\perp Z$ or the independence relationship $Y \perp\!\!\!\perp Z \mid \tilde{T}$ of the HM framework.

- The last column of Table 10 displays the DAG $G_{\overline{T}, \underline{Z}}$ which suppresses the arrow arriving at T and arising from Z .
- Note that the DAGs $G_{\overline{T}, \underline{Z}}$ and $G_{\overline{T}}$ are the same. The LMC of Z for $G_{\overline{T}}$ implies $Z \perp\!\!\!\perp Y$.
- By Rule 1 of DoC, we have that

$$P(Y \mid do(T), Z) = P(Y \mid do(T)).$$

- In summary:

$$G_{\overline{Z}} \Rightarrow Y \perp\!\!\!\perp Z, \Rightarrow \text{by Rule 1 } P(Y \mid do(T), Z) = P(Y \mid do(T)). \quad (11)$$

- This means that Z is statistically independent of Y when we fix T .
- This statement is the exogeneity condition $Y(t) \perp\!\!\!\perp Z$ or the independence relationship $Y \perp\!\!\!\perp Z \mid \tilde{T}$ of the HM framework.
- The LMC of Z is $Z \perp\!\!\!\perp (T, Y, V)$ which implies that $Z \perp\!\!\!\perp T$ holds. Using Rule 2 of the DoC we obtain:

$$G_{\tilde{T}, \underline{Z}} \Rightarrow Y \perp\!\!\!\perp Z \mid T, \text{ so Rule 2 } P(Y \mid do(T), do(Z)) = P(Y \mid do(T), Z). \quad (12)$$

- Combining $P(Y | do(T), Z) = P(Y | do(T))$ in (11) with $P(Y | do(T), do(Z)) = P(Y | do(T), Z)$ in (12) we obtain $P(Y | do(T), do(Z)) = P(Y | do(T))$. This means that the probability distribution of the outcome Y when we fix both Z , T is the same as the counterfactual outcome generated by fixing only the choice T . In the NR framework, this property refers to the exclusion restriction $Y_i(t, z) = Y_i(t, z')$ for all $z, z' \in \text{supp}(Z)$.
- These statements **exhaust** the analysis of the Roy model analysis that can be performed using DoC.
- DoC describes some key properties of the Roy model, but application of its rules alone cannot deliver identification of treatment effects.
- Unfortunately, the type of assumptions that would secure the identification of treatment effects in the Roy model are ruled out by DoC.

The Front-door Model

- To make a more positive statement, it is useful to compare the identification machinery of the DoC and HM using a causal model when treatment effects are identified by DoC.
- We use the Front-Door model of ? to illustrate the differences in the approaches.
- The Front-Door model (13)–(16) consists of three observed variables T , M , Y and an unobserved confounding variable V .

- Treatment T causes a mediator M which in turn causes outcome Y .
- Confounding variable V causes T, Y but not M .¹²

$$V = f_V(\epsilon_V) \quad (13)$$

$$T = f_T(V, \epsilon_T) \quad (14)$$

$$M = f_T(M, \epsilon_M) \quad (15)$$

$$Y = f_Y(M, V, \epsilon_Y) \quad (16)$$

¹²As before, the error terms $\epsilon_V, \epsilon_T, \epsilon_M, \epsilon_Y$ in the front-door model (13)–(16) are mutually statistically independent.

- The causal effect of T on Y in the Front-door model is identified.
- This result arises from the fact that the causal effect of T on M is not confounded by V , and therefore it is identified by standard methods.
- Also, conditioning on T blocks the effect of the confounder V on M . Thus, we can identify the causal effect of M on Y conditional on T .
- The causal effect of T on Y can be evaluated as the compound effect of T on M and M on Y .

Table 11: Using Do-Calculus to Identify the Causal Effect of T on Y in the Front-Door Model

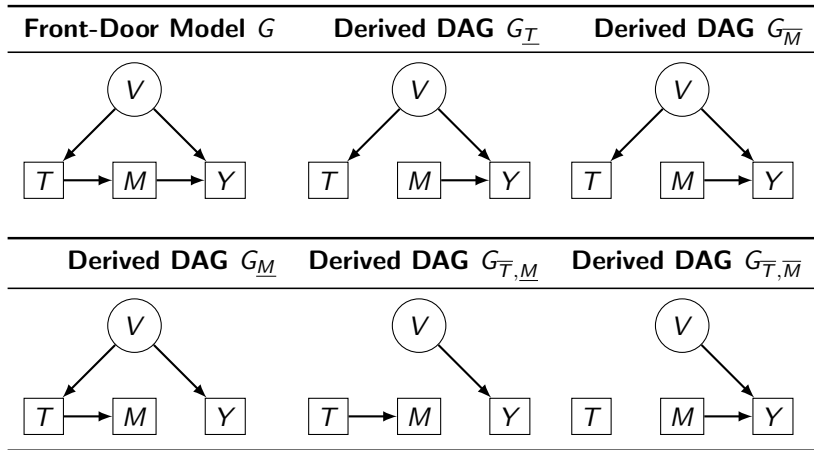

- We illustrate how to use DoC to identify the distribution of the counterfactual outcome $P_h(Y(t))$.
- For sake of notational simplicity, suppose that all variables are discrete. The do-calculus is cumbersome.
- The method requires the five derived DAGs displayed in Table 11.
- The identification formula of the counterfactual outcome is obtained by the following sequence of steps:
 - ① $T \perp\!\!\!\perp M$ in $G_{\underline{T}}$ holds, thus by Rule 2 we have that $P_{e^\dagger}(M \mid do(\underline{T})) = P_e(M \mid T)$.
 - ② $M \perp\!\!\!\perp T$ in $G_{\underline{M}}$ holds, thus by Rule 3 we have that $P_{e^\dagger}(T \mid do(\underline{M})) = P_e(T)$.
 - ③ $M \perp\!\!\!\perp Y \mid T$ in $G_{\underline{M}}$ holds, thus by Rule 2 we have that $P_{e^\dagger}(Y \mid T, do(\underline{M})) = P_e(Y \mid T, M)$

- 4 Adding these results, we have that:

$$\therefore P_e(Y \mid do(M)) = \sum_t P_{e^\dagger}(Y \mid T = t, do(M)) P_{e^\dagger}(T = t \mid do(M))$$

by Law of Iterated Expectations (L.I.E.)

$$= \sum_t P_e(Y \mid T = t, M) P_e(T = t)$$

by steps 1,2, and 3

- 5 $Y \perp\!\!\!\perp M \mid T$ in $G_{\overline{T}, \underline{M}}$ holds, thus by Rule 2,
 $P_{e^\dagger}(Y \mid M, do(T)) = P_{e^\dagger}(Y \mid do(M), do(T))$

- 6 $Y \perp\!\!\!\perp T \mid M$ in $G_{\overline{T}, \overline{M}}$ holds, thus by Rule 3,
 $P_{e^\dagger}(Y \mid do(T), do(M)) = P_{e^\dagger}(Y \mid do(M))$

- 7 Collecting these results, we have that

$$P_{e^\dagger}(Y \mid Z, do(T)) = P_{e^\dagger}(Y \mid do(Z), do(T)) = P_{e^\dagger}(Y \mid do(M)).$$

- 9 Finally, we can use previous results to obtain the following equation:

$$\begin{aligned} & \therefore P_{e\ddagger}(Y | do(T) = t) = \\ & = \sum_m P_{e\ddagger}(Y | M = m, do(T) = t) P_{e\ddagger}(M = m | do(T) = t) \\ & \text{by L.I.E.} \\ & = \sum_m P_{e\ddagger}(Y | do(M) = m, do(T) = t) P_{e\ddagger}(M = m | do(T) = t) \\ & \text{by step 5} \\ & = \sum_m P_{e\ddagger}(Y | do(M) = m) P_{e\ddagger}(M = m | do(T) = t) \\ & \text{by step 7} \\ & = \sum_m \left(\sum_{T=t'} P_e(Y | T = t', M = m) P(T = t') \right) P_e(M = m | T = t) \\ & \text{by step 4} \end{aligned}$$

The Front Door Model in the Hypothetical Model Framework

- We now investigate the same front-door model using the hypothetical framework.
- Table 13 displays the hypothetical model associated with the Front-door model (13)–(16) as a DAG.
- The bottom panel of Table 13 presents the LMC for both models.

Table 12: The Empirical and Hypothetical Front-door Models¹

Empirical Model	Hypothetical Model
LMC	LMC
$V \perp\!\!\!\perp - \mid -$	$V \perp\!\!\!\perp (M, \tilde{T})$
$T \perp\!\!\!\perp - \mid V$	$T \perp\!\!\!\perp (M, Y, \tilde{T}) \mid V$
$M \perp\!\!\!\perp V \mid T$	$M \perp\!\!\!\perp (T, V) \mid \tilde{T}$
$Y \perp\!\!\!\perp T \mid (V, M)$	$Y \perp\!\!\!\perp (T, \tilde{T}) \mid (V, M)$
	$\tilde{T} \perp\!\!\!\perp (T, V)$

- We seek to identify the counterfactual outcome $P_h(Y \mid \tilde{T} = t)$, i.e., to express $P_h(Y \mid \tilde{T} = t)$ in terms of the observed distribution $P_e(T, M, Y)$. Identification requires us to connect the probability distributions of the hypothetical and the empirical models.
- To do so we seek independence relationships that contain T and \tilde{T} , that is, so that $Y \perp\!\!\!\perp \tilde{T} \mid (M, T)$ and $M \perp\!\!\!\perp T \mid \tilde{T}$ hold.¹³
- It is also the case $T \perp\!\!\!\perp \tilde{T}$ holds as \tilde{T} is externally specified (exogenous) and does not cause T .
- We can then apply rules (??)–(??) to generate the following probability equalities:

$$Y \perp\!\!\!\perp \tilde{T} \mid (T, M) \Rightarrow P_h(Y \mid \tilde{T}, T = t', M) = P_e(Y \mid T = t', M)$$

- The causal effect of T on Y of the Front-door model is identified through the following logic:

$$P_h(Y | \tilde{T} = t) = \sum_{t', m} P_h(Y | m, T = t', \tilde{T} = t) P_h(m | T = t', \tilde{T} = t) P_h(T = t' | \tilde{T} = t) \quad (20)$$

$$= \sum_{t', m} P_e(Y | m, T = t') P_e(m | T = t) P_e(T = t') \quad (21)$$

- Equation (20) is a sum of probabilities defined in the hypothetical model by to application of the law of iterated expectation over T and M .
- Equation (21) replaces each of the hypothetical model probabilities with empirical model probabilities using rules (??)-(??).

Understanding the Identification Criteria

- The identification of the counterfactual outcomes in the Front-door Model stems from the three independence relationships in (17)–(19).
- These independence relationships comply with two general properties that facilitate the identification of the counterfactual outcome.
- We clarify the underlying properties that secure identification.
- The first property is called *alternate conditionals*.
- It refers to the fact that the first relationship (17) is an independence relationship regarding T conditional on \tilde{T} .
- The second relationship (18) is an independence relationship of \tilde{T} conditional on T .

- The property of *alternate conditionals* describes an alternating feature to the identification equation (21).
- The first term of (21) is conditioned on $T = t'$ which refers to the first conditional T in (17).
- The identification equation (21) sums t' over the support of T .
- The second term of (21) is conditioned on the treatment value $T = t$. which refers to the second conditional T in (18).
- The value t remains fixed in the summation as it is the value used to define the counterfactual ($Y \mid \tilde{T} = t$).
- The last term in (21) alternates.
- It is conditioned on $T = t'$ which refers to the last conditional T in (19) and t' varies in the summation.

- The second property of the set of independence relationships is called *bridging* and it refers to the variables other than (T, \tilde{T}) .
- The first independence relationship (17) starts with the outcome Y and conditions on the variable M .
- The second relationship (18) starts with M and conditions on no other variable besides T or \tilde{T} .
- We say that variable M bridges the path between Y and (T, \tilde{T}) , that is, $Y \rightsquigarrow M \rightsquigarrow (T, \tilde{T})$.
- In general terms, *bridging* refers to a sequence of nested sets $\mathcal{T}_1 \subset \dots \subset \mathcal{T}_K$ of observed variables in \mathcal{T} such that the property of *alternate conditionals* $Y \perp\!\!\!\perp \tilde{T} \mid (T, \mathcal{T}_K)$, $(\mathcal{T}_K \setminus \mathcal{T}_{K-1}) \perp\!\!\!\perp T \mid (\tilde{T}, \mathcal{T}_{K-1}), \dots$, until $\mathcal{T}_1 \perp\!\!\!\perp T \mid (\tilde{T})$, or $\mathcal{T}_1 \perp\!\!\!\perp \tilde{T} \mid T$ holds.

- Identification is secured whenever a set of conditional independence relationships among observed variables in the hypothetical model exhibits the alternate conditionals and the bridging properties.
- We illustrate these ideas for the complex mediation model of Table 13.
- The model has three observed mediating variables M_1 , M_2 , M_3 (instead of M) and three unobserved, confounding variables V_1 , V_2 , V_3 (instead of V).

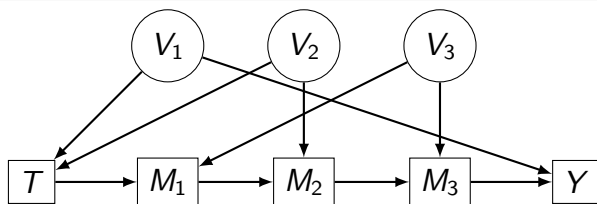
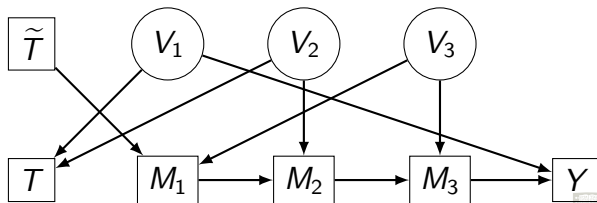
Table 13: Using the HM to Identify Counterfactuals**Directed Acyclic Graph of the Empirical Model****Directed Acyclic Graph of the Hypothetical Model**

- The following conditional independence relationships hold for the hypothetical model:

$$Y \perp\!\!\!\perp \tilde{T} \mid (T, M_3, M_2, M_1) \quad (22)$$

$$M_3 \perp\!\!\!\perp T \mid (\tilde{T}, M_2, M_1) \quad (23)$$

$$M_2 \perp\!\!\!\perp \tilde{T} \mid (T, M_1) \quad (24)$$

$$M_1 \perp\!\!\!\perp T \mid \tilde{T} \quad (25)$$

$$T \perp\!\!\!\perp \tilde{T} \mid T \quad (26)$$

- The set of independence relationships (22)–(26) is a set of *alternate conditionals*.
- The first relationship is conditioned on T , the second on \tilde{T} , followed by T and so on.

- The bridging property also holds.
- The right-hand variable of each independence relationship gives the bridging sequence: $Y \succrightarrow M_3 \succrightarrow M_2 \succrightarrow M_1 \succrightarrow T$.
- We can define the nested sets $\mathcal{T}_1 = \{M_1\}$, $\mathcal{T}_2 = \{M_1, M_2\}$, $\mathcal{T}_3 = \{M_1, M_2, M_3\}$, to rewritten (22)–(26) as:

$$Y \perp\!\!\!\perp \tilde{T} \mid (T, \mathcal{T}_3) \quad (27)$$

$$\mathcal{T}_3 \setminus \mathcal{T}_2 \perp\!\!\!\perp T \mid (\tilde{T}, \mathcal{T}_2, M_1) \quad (28)$$

$$\mathcal{T}_2 \setminus \mathcal{T}_1 \perp\!\!\!\perp \tilde{T} \mid (T, \mathcal{T}_1) \quad (29)$$

$$\mathcal{T}_1 \perp\!\!\!\perp T \mid \tilde{T} \quad (30)$$

$$T \perp\!\!\!\perp \tilde{T} \mid T \quad (31)$$

- The law of iterated expectations and independence relationships (22)–(26) enable us to express the counterfactual probability $P_h(Y | \tilde{T})$ as:

Hypothetical Model

$$P_h(Y | \tilde{T} = t) = \sum_{t', m_3, m_2, m_1} A_h \cdot B_h \cdot C_h \cdot D_h \cdot E_h,$$

where:

$$A_h = P_h(Y | m_3, m_2, m_1, T = t', \tilde{T} = t)$$

$$B_h = P_h(M_3 = m_3 | m_2, m_1, T = t', \tilde{T} = t)$$

$$C_h = P_h(M_2 = m_2 | m_1, T = t', \tilde{T} = t)$$

$$D_h = P_h(M_1 = m_1 | T = t', \tilde{T} = t)$$

$$E_h = P_h(T = t' | \tilde{T} = t)$$

- The connection rules (??)–(??) enable us to translate hypothetical probabilities into empirical probabilities. The identification equation displays the alternative pattern of values t and t' in the same fashion as the identification equation of the Front-door model:

Empirical Model

$$P_e(Y(t)) = \sum_{t', m_3, m_2, m_1} A_e \cdot B_e \cdot C_e \cdot D_e \cdot E_e,$$

where:

$$A_e = P_e(Y \mid m_3, m_2, m_1, T = t')$$

$$B_e = P_e(M_3 = m_3 \mid m_2, m_1, T = t)$$

$$C_e = P_e(M_2 = m_2 \mid m_1, T = t')$$

$$D_e = P_e(M_1 = m_1 \mid T = t)$$

$$E_e = P_e(T = t')$$

Comparing DoC and HM Frameworks

- Both DoC and HM employ structural equations and describe causal models with both observed and unobserved variables.
- They clearly separate the task of defining counterfactuals and identifying them. Both frameworks enable analysts to disentangle the tasks of causal analysis in Table ??.
- Both frameworks employ scientific knowledge to define causal models (Task 1) and the structural equations that underlie the approach.
- There are, however, some distinct practices in DoC and HM. When DoC fixes a treatment variable, it *eliminates* the variable from the joint distribution of variables.
- All the DoC analysis is done within the empirical model so generated.

- HM does *not* eliminate the equation for the treatment variable.
- Instead, it adds a hypothetical variable. The presence of both treatment and hypothetical variables in the HM framework facilitates the study of the causal effects.
- They readily analyze both external manipulation and conditioning, such as the treatment on the treated, whereas this is outside the scope of DoC.
- It facilitates examination of causal inference for direct and indirect effects in which the hypothetical variable replaces some but not all the treatment inputs of the structural equations. DoC needs to invent new rules to undertake those tasks. For each combination of conditioning variables.

- The identification of causal effects (Task 2) requires connecting the hypothetical model with the empirical model.
- HM employs two statistical implications to connect the probability distributions of the hypothetical and empirical models.
- HM implications remain within the realm of standard statistical theory and do not require invocation of non-probabilistic DAG-based rules.

- The DoC machinery consists of three DAG-based rules.
- It constructs a series of possible DAGs.
- Each of them constitutes a causal model that modifies the empirical model.
- Each modification of the empirical model corresponds to introducing a new set of conditional independence relationships.
- The search for the combinations of DAGs and conditional independence relationships are required to identify counterfactuals grows exponentially. An algorithm has been developed to perform this task.¹⁴
- Calculations with HM are simpler than those based on DoC. They rely on a single modification of the original DAG, as encoded in the hypothetical model instead of a growing list of DAGs to implement the three guiding rules of DoC.

¹⁴See ?.

- DoC relies critically on DAGs, conditional independence relationships, and a special set of rules.
- The HM machinery remains within the statistical realm to make statistics converse with causality.
- In doing so, the method is capable to accommodate assumptions that explore functional form restrictions or distributional assumptions outside the scope of DoC.

3. Simultaneous Causality

- The Generalized Roy model is usually expressed as a recursive model.¹⁵ However, simultaneous causality is a property of many economic models.
- Examples of such models include social interactions, general equilibrium, Walrasian market clearing, or simultaneous play in Nash models of industrial organization are staples of economic theory (see, e.g., ?).
- These type of models are ignored in most discussions of causality in the NR literature.
- The NR approach commonly invokes the Stable Unit Treatment Value Assumption (SUTVA), which excludes the possibility of interaction between agents.¹⁶

¹⁵See, however, ??.

¹⁶See, for instance, ?.

- It is instructive to consider these models because they challenge the approximating approaches in the literature, but are easily analyzed in econometric causal policy analysis.
- The pioneering econometric models featured simultaneity. Many of the core ideas are ignored or remain unknown to the followers of the approximating approaches, which rely on recursive formulations, and are considered as essential features of causal models.
- In fact, these are at best only convenient assumptions for analyzing causal models, used as special by economists for generations.¹⁷

¹⁷See ?.

- Simultaneous causality is an essential feature of structural equation models.¹⁸
- The LISREL model of ? allows for simultaneity, measurement error and latent variables proxied by measurements as discussed in Section ??.
- The structural systems typically consist of two parts: (a) an autonomous system expressed in terms of latent variables (?) and (b) a measurement system. The measurement system proxies the latent variables. The first part of the structural system consists of structure for person i :

$$\eta_i = \alpha_\eta + \beta\eta_i + \Gamma\chi_i + \omega_i \quad (32)$$

where η_i , ε_i , χ_i are vectors of latent variables.

¹⁸See ? and ?.

- The measurement system consists of vectors of measurements:

$$\text{Measurement: } \begin{cases} y_i = \alpha_y + \Lambda_y \eta_i + \varepsilon_i & (\text{measurement for } \eta_i) \\ \chi_i = \alpha_x + \lambda_x U = \xi_i & (\text{measurement for } \chi_i) \end{cases}$$

- These models have been extended to time series and panel data settings (see e.g. ??).
- In a valuable paper, ? exposit this system of equations as a causal model with simultaneity and show how various measurement systems use factor models and other approaches to proxy the latent variables which may be the variables measured with error or omitted variables, like ability in an earnings equation, or technical efficiency in a production function.

- They dispel many misguided criticisms of the structural approach lodged by advocates of the NR approach. These systems are equipped to use cross equation restrictions and covariance restrictions to secure identification of causal parameters.
- This literature is rich and we lack the space to exposit it thoroughly.
- We note that these systems illustrate—in linear equation models—an approach for proxying V as previously discussed.
- It is also an approach for studying mediation where analysts can study how interventions on χ_i percolate through equation system (25). ? summarizes a large literature on nonparametric factors and proxy models.

- Instead of a general exposition of these systems, we consider a simple simultaneous equations model due to ?. We consider a system of two autonomous causal (structural) equations:

$$Y_1 = g_{Y_1}(Y_2, X_1, U_1, \epsilon_1) \quad (33)$$

$$Y_2 = g_{Y_2}(Y_1, X_2, U_2, \epsilon_2) \quad U_1 \not\perp U_2. \quad (34)$$

- We use this system to demonstrate how causality can be analyzed in simultaneous systems.

- This system of equations gives two maps:
 $g_{Y_1} : (Y_2, X_1, U_1) \rightarrow Y_1$; $g_{Y_2} : (Y_1, X_1, U_2) \rightarrow Y_2$. Y_1 and Y_2 could be actions of a pair of interacting agents.¹⁹
- To simplify the discussion, we assume that both equations are twice continuously differentiable. This is a convenience and not a necessity.
- The model of equations (33)–(34) are treated in a special way in the DoC approach.
- We focus on a two equation system to simplify the exposition. Models with multiple simultaneous equations are standard in the literature (see, e.g., ???????).

¹⁹In the literature on peer effects, simultaneous equation problems are relabeled “reflection problems.” See ??.

- Equations (33) and (34) are assumed to be structural, i.e., invariant under manipulations of their arguments, so they are stable, autonomous maps. Policies consist of manipulations of their arguments.
- In the classical model of market clearing equilibrium, Y_1 is price; Y_2 is quantity and X_1 , X_2 , U_1 , and U_2 are causal determinants.
- Equations (33) and (34) are generated by thought experiments varying the arguments and tracing out the outcomes.
- Thus, (33) is the market price that is consistent with hypothetical values Y_2 , X_1 , U_1 . (34) is the analogous relationship for quantity.
- The addition of unobserved (by the economist) variables U_1 and U_2 is made in anticipation of empirical applications. In the peer effects literature, Y_1 and Y_2 are behaviors of two interacting agents (e.g., smoking or drug use).

- In terms of our previous notation, the variable set is $\mathcal{T}_e = \{Y_1, Y_2, X_1, X_2, U_1, U_2\}$.
 $\mathbb{M}_e(Y_1) = \{Y_2, X_1, U_1\}$ and $\mathbb{M}_e(Y_2) = \{Y_1, X_2, U_2\}$.
- The empirical and hypothetical models are displayed as DAGs in Table 14 given by:

Table 14: Empirical and Hypothetical Causal Models

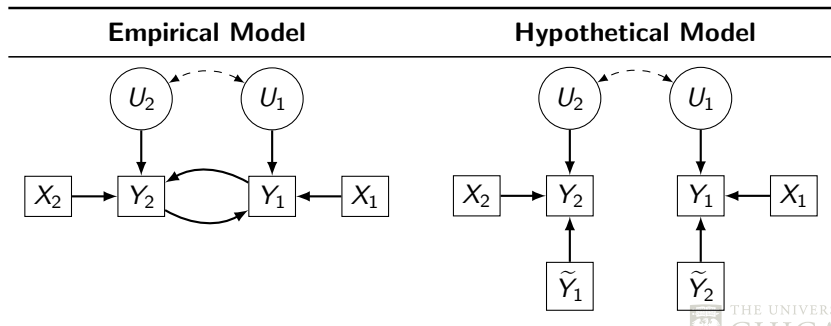

- The LMC condition breaks down so the Bayesian net approach fails.
- “Fixing” and the hypothetical model approach readily extend to a system of simultaneous equations for Y_1 and Y_2 , whereas the fundamentally recursive methods based on DAGs require special treatment.

3.1. Completeness

- “Completeness” assumes the existence of at least a local solution for Y_1 and Y_2 in terms of (X_1, X_2, U_1, U_2) :

$$Y_1 = \phi_1(X_1, X_2, U_1, U_2) \quad (35)$$

$$Y_2 = \phi_2(X_1, X_2, U_1, U_2). \quad (36)$$

- These are **reduced form** equations (see, e.g., ???).
- They inherit the autonomy properties of the structural equations.
- Completeness is a property that guarantees the conceptual possibility of simultaneity, which is not necessarily guaranteed. If it fails, the existence of consistent solutions to (33) and (34) is not guaranteed.
- Nonetheless autonomous correspondences may still exist and they can be used to make set-valued causal inferences.²⁰

²⁰See, e.g., ???.

- The causal effect of Y_2 on Y_1 when Y_2 is fixed at y_2 is generated by

$$Y_1(y_2) = g_{Y_1}(y_2, X, U_1).$$

- Symmetrically, the causal effect of Y_1 on Y_2 when Y_1 is fixed at y_1 is generated by:

$$Y_2(y_1) = g_{Y_2}(y_1, X, U_2).$$

- The relationships (33) and (34) can be defined even if they might not be identified or estimated.
- The *completeness assumption* says that there are values of X_1, X_2, U_1, U_2 that generate values of Y_1, Y_2 consistent with (33) and (34). These involve hypothetical variations.
- For certain models no such sets of variables may exist.

3.2. Can We Hypothetically Vary Y_2 and Y_1 ?

- If Y_2 and Y_1 are simultaneously determined, the notion of varying Y_2 to change Y_1 may seem impossible. ? preserves his focus on recursive models and addresses this problem in a very special way by assuming structural invariance and “shutting one equation down,” assuming the rest of the system remains unchanged.
- Thus, for example, equation (34) is suspended, but (33) is maintained.
- This is consistent with the logic of do-calculus, which eliminates relationships from systems, assuming invariance of the remaining system. He sets Y_2 to a constant that can be manipulated in (33).
- This thought experiment converts a simultaneous system into a recursive system with all other equations assumed to hold as before.

- This approach is cumbersome and strains credibility in many interlinked economic contents (e.g., person 1 influences 2, but not vice versa) but is logically possible. It is unnecessary if exclusions in (33) and (34) are used.
- To show this, we define exclusion of X_2 in (33) as $\frac{\partial g_{Y_1}}{\partial X_2} = 0$ for all (Y_2, X_1, X_2, U_1) .²¹ Exclusion of X_1 in (34) is defined as $\frac{\partial g_{Y_2}}{\partial X_1} = 0$ for all (Y_1, X_1, X_2, U_2) . Implicit is the assumption that components of X_1 and X_2 can be varied.
- Under completeness and exclusion X_2 from (34), by the chain rule, the causal effect of Y_2 on Y_1 is

$$\frac{\partial g_{Y_1}}{\partial Y_2} = \frac{\partial Y_1}{\partial X_2} \bigg/ \frac{\partial Y_2}{\partial X_2} = \frac{\partial \varphi_1}{\partial X_2} \bigg/ \frac{\partial \varphi_2}{\partial X_2}.$$

²¹Or more generally, X_2 is not an argument of g_{Y_N} .

- We may define and identify causal effects for Y_1 on Y_2 in an analogous fashion. Variations in X_1 and X_2 that respect completeness define the causal parameters when the components of X_1 and X_2 can be independently varied.²²
- No implausible “shutting down” of any equation in a system and assuming autonomy of the remaining system is required.
- This logic is now standard and is the basis for an estimation technique, “indirect least squares” (see ? and ??).
- It demonstrates the flexibility of the econometric approach for defining and identifying causal parameters outside the narrow world of DAGs. ? gives a range of approaches for identifying systems like (33) and (34) using restrictions within and across equations for observables and unobservables.

²²Assuming that the completeness condition is part of the thought experiment. In some contexts it may be ruled out as not credible.

3.3. Econometric Mediation Analysis

- We have already discussed mediation analyses in recursive models. These notions extend to models with simultaneity.
- Under completeness, reduced forms (35) and (36) estimate the **net effect** of a policy change X_1 :

$$\frac{\partial Y_1}{\partial X_1} = \frac{\partial \phi_1(X_1, X_2, U_1, U_2)}{\partial X_1}. \quad (37)$$

- Following ? and ??, we can conduct “mediation analyses” that address problem **P-2** and trace the impact of an externally manipulated X_1 on Y_1 , both through its direct effect on (33) and its indirect effect through Y_2 :

$$\frac{\partial Y_1}{\partial X_1} = \underbrace{\left(\frac{\partial g_{Y_1}}{\partial Y_2} \right) \left(\frac{\partial Y_2}{\partial X_1} \right)}_{\substack{\text{From Structure} \\ \text{From Reduced Form} \\ \text{Indirect effect} \\ \text{through } Y_2}} + \underbrace{\frac{\partial g_{Y_1}}{\partial X_1}}_{\substack{\text{From Structure} \\ \text{Direct effect}}} = \frac{\partial \phi_1(X_1, X_2, U_1, U_2)}{\partial X_1}$$

- This approach can be readily applied to recursive systems and general multiple equation systems. Reliance on linear equations, while traditional in the literature, is not necessary and nonparametric approaches are available.²³
- Mediation is a staple of econometric policy evaluation to examine all channels of influence of variables (see, e.g., ?).
- All of the tools used to analyze simultaneous equations are available to estimate these models (See e.g., ???).

²³See ??? for nonparametric analyses of such systems.

4. Conclusion

Conclusion

- This paper presents the basic framework of the econometric model for causal policy analysis. We discuss the definition of causal parameters and approaches to their identification within it.
- We consider two approximations to it that are current in the literature on causal inference and their relationship with the econometric approach.
- The econometric model is based on clearly stated and interpretable models of behavior that adequately characterize the lessons of economic theory and allow for testing it, for synthesizing evidence on it from multiple sources, constructing credible policy counterfactuals, including forecasting policy impacts in new environments and forecasting the likely impacts of policies never previously implemented.
- The econometric approach delineates the definition of causal

Conclusion

- The two approximating approaches are: (a) the Neyman-Rubin approach rooted in the statistics of experiments, and (b) the do-calculus that originated in computer science. Both are recent developments that attempt to address some of the same problems tackled by the econometric approach.
- Each has important, but different, limitations.
- Neither has the flexibility or clarity of the econometric approach.
- All start from the basic intuitive definition of a causal effect as a *ceteris paribus* consequence of a policy change.
- However, the rules of constructing and identifying counterfactuals are very different.

Conclusion

- The do-calculus invokes a special set of rules for identifying causal parameters that lie outside of probability theory and that use a limited class of identifying assumptions for behavioral equations.
- It relies heavily on recursive directed acyclic graphs and assumptions about conditional independence. Its rigid rules preclude the use of many traditional techniques of identification and estimation.

Conclusion

- The Neyman-Rubin approach eschews the benefits of structural equations and many fruitful strategies for their identification.
- Reflecting its origins, it casts all policy problems into a “treatment-control” framework.
- In some versions, it conflates issues of definition with issues of identification.
- Its lack of reliance on structural equations with explicit links to theory and explicit analyses of unobservables, makes it difficult to interpret estimates obtained from it or to analyze well-posed economic questions with it using the large toolkit of modern econometrics.
- Economics has a rich body of theory and tools to address policy problems.
- Applied economists would do well by using the impressive set of conceptual tools available from econometric theory.